

# GSL

SL-Series





<b>The d&amp;b System reality</b> .....	4
<b>The SL-Series</b> .....	6
<b>The GSL8 loudspeaker</b> .....	10
<b>The GSL12 loudspeaker</b> .....	11
<b>The SL-SUB and SL-GSUB</b> .....	12
<b>The SL-Series rigging modes</b> .....	13
<b>The GSL rigging system</b> .....	14
<b>The GSL rigging examples</b> .....	15
<b>The GSL carts</b> .....	16
<b>The GSL carts examples</b> .....	17
<b>The d&amp;b ArrayCalc simulation software</b> .....	18
<b>The d&amp;b R1 Remote control software</b> .....	20
<b>The d&amp;b NoizCalc immission modelling software</b> .....	21
<b>The DS10 and DS20 Audio network bridges</b> .....	22
<b>The DS100 Signal Engine</b> .....	22
<b>The D80 amplifier</b> .....	23
<b>The D80 Touring rack assembly</b> .....	24
<b>The SL-Series system package</b> .....	25
<b>The controller setups and operation with D80 amplifier</b> .....	26
<b>The GSL System frequency responses</b> .....	27
<b>The GSL System configuration examples</b> .....	28
<b>The GSL System cables and adapters MC8/MC24</b> .....	32
<b>The GSL System product overview</b> .....	34

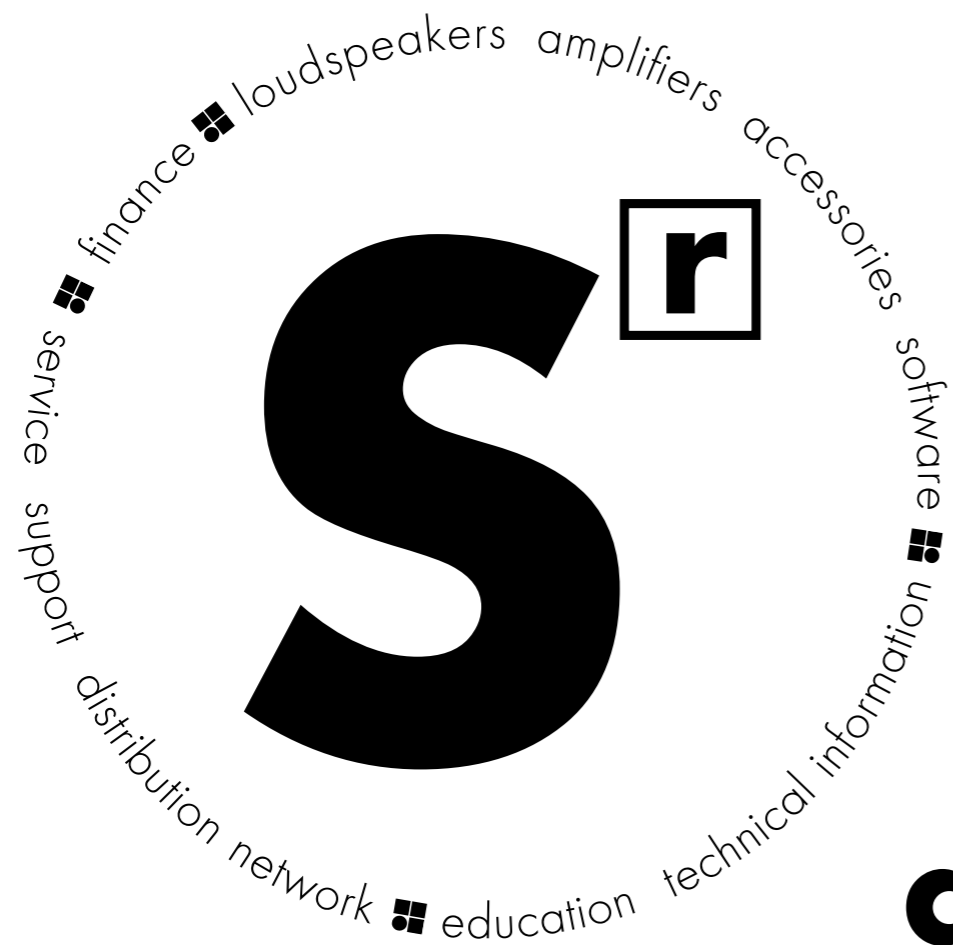

# d&b System reality

As the name implies a d&b audiotechnik system is not just a loudspeaker. Nor is it merely a sum of the components: loudspeakers, amplifiers, signal processors, networking, software and accessories. Right from the outset the d&b audiotechnik approach was to build integrated sound reinforcement systems

that actually are more than the combination of parts: an entirety where each fits all. Every element is tightly specified, precisely aligned and carefully matched to achieve maximum efficiency. For ease of use, all the user-definable parameters are incorporated, allowing the possibility of adjustment, either

directly, via remote control surfaces, or integrated within wider networks. Neutral sound characteristics leave the user all the freedom needed to realize whatever the brief. At the same time d&b offers finance, service and support, a knowledgeable distribution network, education and training as well as technical

information, so the same optimal acoustic result is achieved consistently by every system anywhere, at any time. In reality: the d&b System reality.



The SL-Series is a family of audio systems hailing from applied evolution; a development in more than one dimension delivering unprecedented directivity control and headroom over the entire audio spectrum. This couples with significant low frequency extension, comprehensive rigging, cabling and transportation solutions, all optimized for the highest speed of

deployment. The precise broadband directivity control curtails energy radiating to the rear of the systems right down to the lowest frequencies. This reduces the level radiating back to the stage, making more comfortable performance environments and diminishing lower frequency spill on open mics. When indoors, the accuracy of directivity control significantly

decreases stimulation of the reverberant field, while outdoors it keeps the energy focussed on the audience to substantially reduce any unwanted immissions. The GSL System, and its smaller sibling the KSL System, are complete packages specifically designed to accurately deliver messages across all performance styles and musical genres over a wide variety of

applications in theatres, concert halls, arenas, stadiums as well as festivals, whether mobile or installed. The SL-Series combines unparalleled audio performance with maximum efficiency, neatly aligned to the system design, deployment, optimization and control capabilities of the tried and tested d&b Workflow.

# The GSL System

The **GSL System** is a part of the holistic d&b approach addressing the broadest range of applications where high quality sound reinforcement and reproduction are a prerequisite. The resulting systems are based on many years of applied evolution, where a clear understanding of the tasks and requirements has been coupled with advances in available technology and streamlined to achieve optimal results. The component parts described here combine to form systems, all the elements fitting together within the d&b Workflow to deliver ease of use, predictability of results, flexibility and speed of deployment.

The **GSL8 and GSL12** line array modules are specifically designed for large scale sound reinforcement. Sharing the same vertical directivity, size, footprint, weight, rigging and driver complement, up to twenty-four GSL loudspeakers can be flown in vertical columns. The 2-Way active design combines ingenious cabinet geometry with forward and side firing low frequency drivers, these couple towards the front, cancel towards the rear and increase low frequency headroom. The driver complement is completed by a hornloaded mid range and three high frequency drivers mounted to a waveshaping device. The 80° horizontal directivity pattern of the GSL8 is seamlessly maintained down to the lowest frequencies the loudspeaker produces, while the GSL12 has a wider horizontal dispersion pattern of 120°.

The **SL-SUB** is equipped with flying fittings, while the **SL-GSUB** is for ground stack use only. The bass-reflex design uses three 21" high excursion drivers, one of which radiates to the rear to produce cardioid subwoofer performance, avoiding unwanted energy behind the system. The SL-SUB and SL-GSUB extend the bandwidth of a GSL System down to 30 Hz and increases headroom. The SL-SUB and SL-GSUB can be deployed in conventional left and right ground stacked setups as well as in distributed SUB arrays to achieve an even venue specific coverage pattern.

The patented SL-Series rigging method and flying hardware enables rapid deployment of GSL8 and GSL12 arrays directly from the Touring cart in either compression or tension rigging modes. For the compression mode, a straight array is flown from the Touring carts, after which a hoist or hand winch is used to curve the array to the defined splay angles. Designed to fit within standard shipping container and truck sizes, the GSL Touring cart accommodates four GSL8 or GSL12 loudspeakers, including flying frames and a transport cover. The SL-SUB Touring Cart can house up to three SL-SUB or SL-GSUBs with respective covers.



**GSL8 loudspeaker**



**GSL12 loudspeaker**



**SL-SUB**



**SL-GSUB**

The **d&b ArrayCalc simulation software** allows the virtual optimization of line arrays, point source and column loudspeakers as well as subwoofers and their adjustment to venue conditions. The **d&b NoizCalc immission modelling software** uses international standards to model noise immission from d&b loudspeaker systems. NoizCalc takes data from ArrayCalc and calculates the sound propagation towards the far field. The complete system configuration simulated in ArrayCalc is assimilated by the **d&b R1 Remote control software** into an intuitive graphical user interface to manage the system from anywhere in the venue.

A wide range of tools and data files are available to support the planning process using external tools. For enhanced acoustic simulations, all loudspeakers offer EASE files. BIM (Building Information Modelling) is supported with Revit files available for all loudspeakers and accessories, creating accurate project data and visualization. 2D and 3D CAD data is usable in most common planning tools. Venue data created by SketchUp can be imported to ArrayCalc using the d&b sketchup plug-in to facilitate system design.

d&b amplifiers are specifically designed for use with d&b loudspeakers, and are at the heart of the d&b system approach. These devices contain extensive Digital Signal Processing capabilities to provide comprehensive loudspeaker management and specific switchable filter functions to precisely target the system response for a wide variety of applications. The four channel **D80** amplifier is intended for both mobile and installation applications requiring the highest Sound Pressure Levels. The d&b amplifiers provide extensive user-definable equalization containing two 16-band equalizers with parametric, notch, shelving and asymmetric filters as well as delay capabilities of up to 10 seconds.

The d&b Audio network bridges interface between audio transport networks and AES3 digital audio signals while also providing distribution of Ethernet control data. The **DS10** supports Dante networks, while the **DS20** is used for the open standards-based Milan protocol.

The **DS100 Signal Engine** is a specialized rack mount 3 RU audio processor with Dante networking. It provides a 64 x 64 audio matrix with level and delay adjustments at all cross points. Additional software modules provide source positioning and emulated acoustics functions.



**D80 amplifier**



**DS10 Audio network bridge**



**DS20 Audio network bridge**



**DS100 Signal Engine**

# The GSL8 loudspeaker

## GSL8 loudspeaker

The GSL8 line array module produces an 80° constant directivity dispersion pattern in the horizontal plane over the entire operating bandwidth. The GSL8 houses two 14" neodymium forward facing LF drivers and two side firing 10" neodymium LF drivers. A coaxial mid-high section contains an MF horn with a 10" driver and three 1.4" exit HF compression drivers with 3.4" voice coils mounted to a wave shaping device. SL-Series flying hardware has a patented workflow with integrated tension and compression rigging modes, allowing splay angles from 0° to 7° in 1° increments. The loudspeakers are driven actively by two channels of an appropriate d&b amplifier. One channel powers the 14" LF drivers, the second channel powers all other components, which are passively crossed-over. The component geometry provides consistent, accurate horizontal dispersion control, which the front and side firing LF driver arrangement maintains seamlessly down to the lowest frequencies produced. The cabinets are constructed from marine plywood and have an impact and weather protected PCP (Polyurea Cabinet Protection) finish. The front and side panels incorporate rigid metal grills backed by an acoustically transparent and water repellent fabric. Each side panel incorporates a recessed handle, with additional handles provided at the rear.

## System data

Frequency response (-5 dB standard) ..... 45 Hz - 18 kHz  
 Frequency response (-5 dB CUT mode)..... 70 Hz - 18 kHz  
 Max. sound pressure (1 m, free field).....  
 with D80 ..... 150 dB<sup>1</sup>

## Loudspeaker data

Nominal impedance front LF ..... 4 ohms  
 Nominal impedance side LF/MF/HF ..... 4 ohms  
 Power handling capacity front (RMS/peak 10 ms) ... 800W/3200W  
 Power handling capacity side (RMS/peak 10 ms) .... 800W/3200W  
 Nominal dispersion angle (horizontal) ..... 80°  
 Splay angle settings ..... 0 ... 7° (1° increment)  
 Components ..... 2 x 14" front LF driver  
 ..... 2 x 10" side LF driver  
 ..... 1 x 10" MF driver  
 ..... 3 x 1.4" exit compression driver with 3.4" coil  
 ..... Passive crossover network  
 Connections ..... 1 x NLT4 F  
 Weight ..... 80 kg (176 lb)

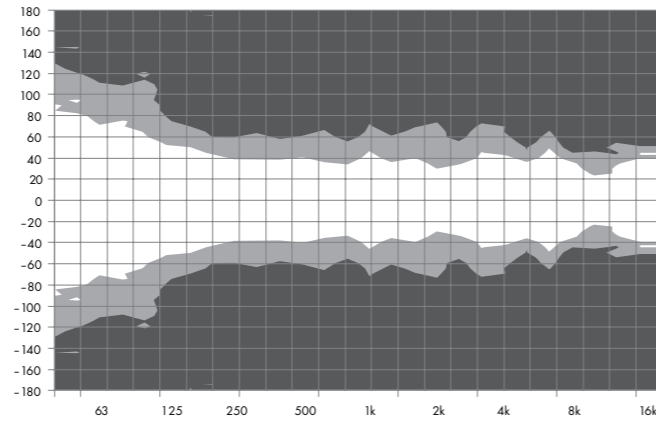

GSL8 horizontal dispersion characteristics<sup>2</sup>

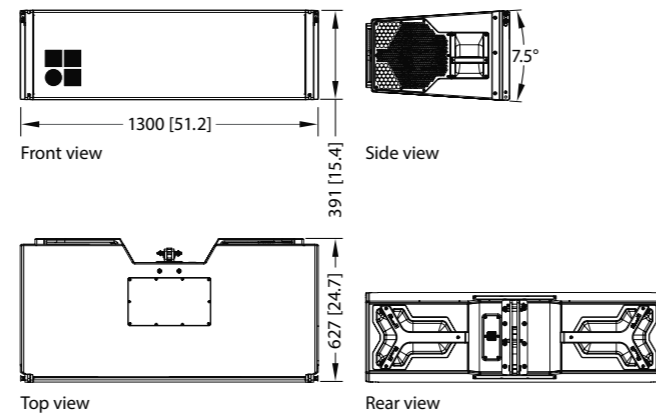

GSL8 cabinet dimensions in mm [inch]

<sup>1</sup> SPLmax: Broadband signal IEC 60268  
<sup>2</sup> Dispersion angle vs frequency plotted using lines of equal sound pressure (isobars) at -6 dB and -12 dB

# The GSL12 loudspeaker

## GSL12 loudspeaker

The GSL12 line array module produces an 120° constant directivity dispersion pattern in the horizontal plane over the entire operating bandwidth. The GSL12 houses two 14" neodymium forward facing LF drivers and two side firing 10" neodymium LF drivers. A coaxial mid-high section contains an MF horn with a 10" driver and three 1.4" exit HF compression drivers with 3.4" voice coils mounted to a wave shaping device. SL-Series flying hardware comes with a patented workflow with integrated tension and compression rigging mode, allowing splay angles from 0° to 7° in 1° increments. The loudspeakers are driven actively by two channels of an appropriate d&b amplifier. One channel powers the 14" LF drivers, the second channel powers all other components, which are passively crossed-over. The component geometry provides consistent, accurate horizontal dispersion control, which the front and side firing LF driver arrangement maintains seamlessly down to the lowest frequencies produced. The cabinets are constructed from marine plywood and have an impact and weather protected PCP (Polyurea Cabinet Protection) finish. The front and side panels incorporate rigid metal grills backed by an acoustically transparent and water repellent fabric. Each side panel incorporates a recessed handle, with additional handles provided at the rear.

## System data

Frequency response (-5 dB standard) ..... 45 Hz - 18 kHz  
 Frequency response (-5 dB CUT mode)..... 70 Hz - 18 kHz  
 Max. sound pressure (1 m, free field).....  
 with D80 ..... 149 dB<sup>1</sup>

## Loudspeaker data

Nominal impedance front LF ..... 4 ohms  
 Nominal impedance side LF/MF/HF ..... 4 ohms  
 Power handling capacity front (RMS/peak 10 ms) ... 800W/3200W  
 Power handling capacity side (RMS/peak 10 ms) .... 800W/3200W  
 Nominal dispersion angle (horizontal) ..... 120°  
 Splay angle settings ..... 0 ... 7° (1° increment)  
 Components ..... 2 x 14" front LF driver  
 ..... 2 x 10" side LF driver  
 ..... 1 x 10" MF driver  
 ..... 3 x 1.4" exit compression driver with 3.4" coil  
 ..... Passive crossover network  
 Connections ..... 1 x NLT4 F  
 Weight ..... 80 kg (176 lb)

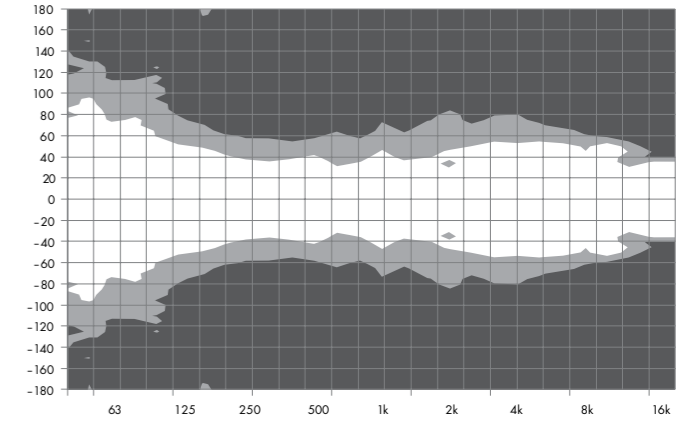

GSL12 horizontal dispersion characteristics<sup>2</sup>

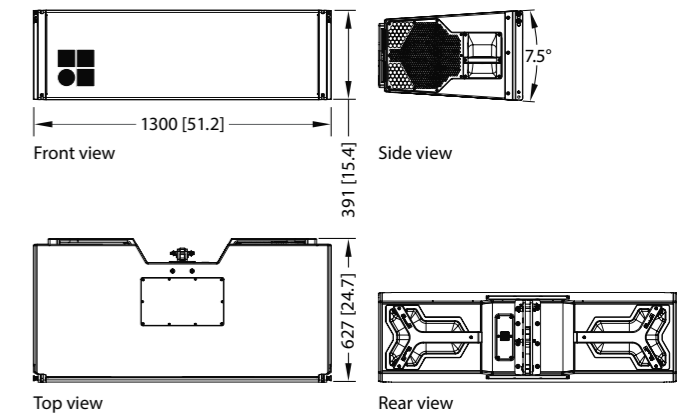

GSL12 cabinet dimensions in mm [inch]

<sup>1</sup> SPLmax: Broadband signal IEC 60268  
<sup>2</sup> Dispersion angle vs frequency plotted using lines of equal sound pressure (isobars) at -6 dB and -12 dB

# The SL-SUB and SL-GSUB

## SL-SUB and SL-GSUB

The SL-SUB and SL-GSUB are cardioid subwoofers to compliment the GSL8 and GSL12 loudspeakers. The SL-SUB rigging hardware allows columns of up to 14 cabinets to be flown while the SL-GSUB is intended for ground stacked applications only. Both subwoofers are actively driven, 2-way bass-reflex designs housing three long excursion 21" neodymium drivers. Two drivers face to the front while one radiates to the rear. The front and rear facing drivers operate in independent bass reflex chambers and are driven from separate amplifier channels. The cardioid dispersion pattern reduces unwanted energy behind the system, resulting in less excitation of the reverberant field to deliver highly accurate low frequency reproduction. The frequency response extends from 33 to 84 Hz/30 to 65 Hz. The SL-SUB cabinet incorporates front and rear rigging strands while the SL-GSUB has no rigging components and is intended for ground stack purposes.

The cabinets are constructed from marine plywood with an impact and weather protected PCP (Polyurea Cabinet Protection) finish. The front and rear of the subwoofers are protected by rigid metal grills backed by an acoustically transparent and water repellent fabric. Two runners extend from the front to rear to protect the bottom panel. Two correspondingly shaped recesses are incorporated in the top panel accepting the runners and preventing cabinet movement when subwoofers are stacked. The side panels incorporate four recessed handles and four heavy duty wheels are mounted on the rear of the subwoofers.

## System data

Frequency response (-5 dB standard) ..... 33 Hz - 84 Hz  
 Frequency response (-5 dB INFRA mode) ..... 30 Hz - 65 Hz  
 Max. sound pressure (1 m, free field) .....  
 with D80 ..... 144 dB<sup>1</sup>

## Loudspeaker data

Nominal impedance front/rear ..... 3/6 ohms  
 Power handling capacity front (RMS/peak 10 ms).... 1000/4000  
 Power handling capacity rear (RMS/peak 10 ms) .500/2000 W  
 Components ..... 3 x 21" driver  
 Connections ..... 1 x NLT4 F  
 Weight ..... SL-SUB 138 kg (304 lb)  
 Weight ..... SL-GSUB 132 kg (291 lb)

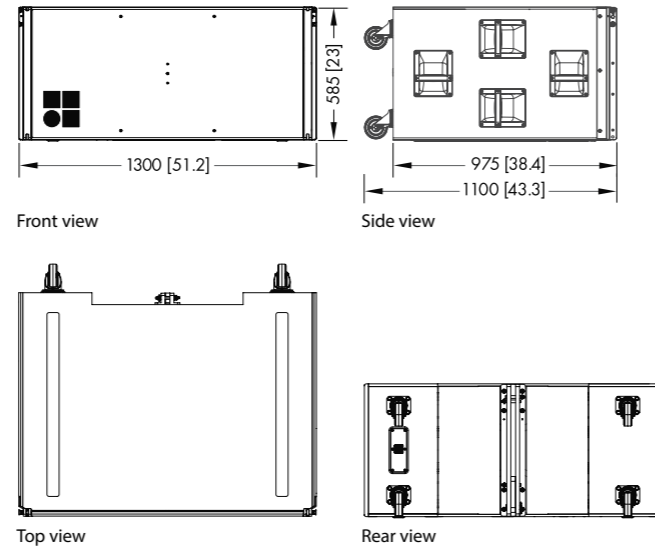

SL-SUB/SL-GSUB cabinet dimensions in mm [inch]

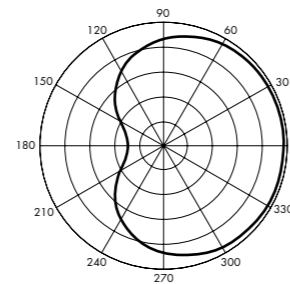

Cardioid polar pattern

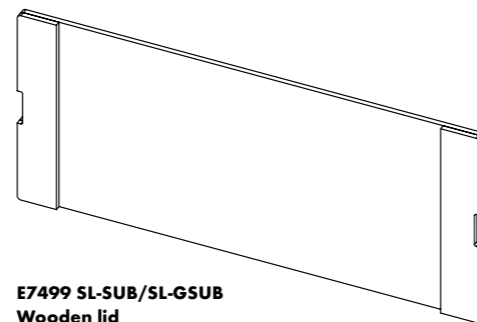

E7499 SL-SUB/SL-GSUB Wooden lid

# The SL-Series rigging modes

## Tension and compression modes

The GSL System rigging has been optimized to incorporate solutions for every eventuality. The patented flying hardware and method enables rapid deployment of GSL8 and GSL12 arrays directly from the Touring cart in either compression or tension rigging modes. Tension mode uses the well-established d&b three-point rigging, while the compression mode needs a smaller footprint and is faster and safer for large arrays. Loudspeakers are flown as straight arrays, the d&b Z5724 Compression set curves the array to produce the coverage defined by the splay angle settings; a motorized chain hoist may also be used.<sup>1</sup>

Mounted directly on the GSL Flying frame, the d&b ArraySight laser inclinometer contains temperature and humidity sensors, this information is relayed to the R1 Remote control software using the OCA/AES70 protocol.

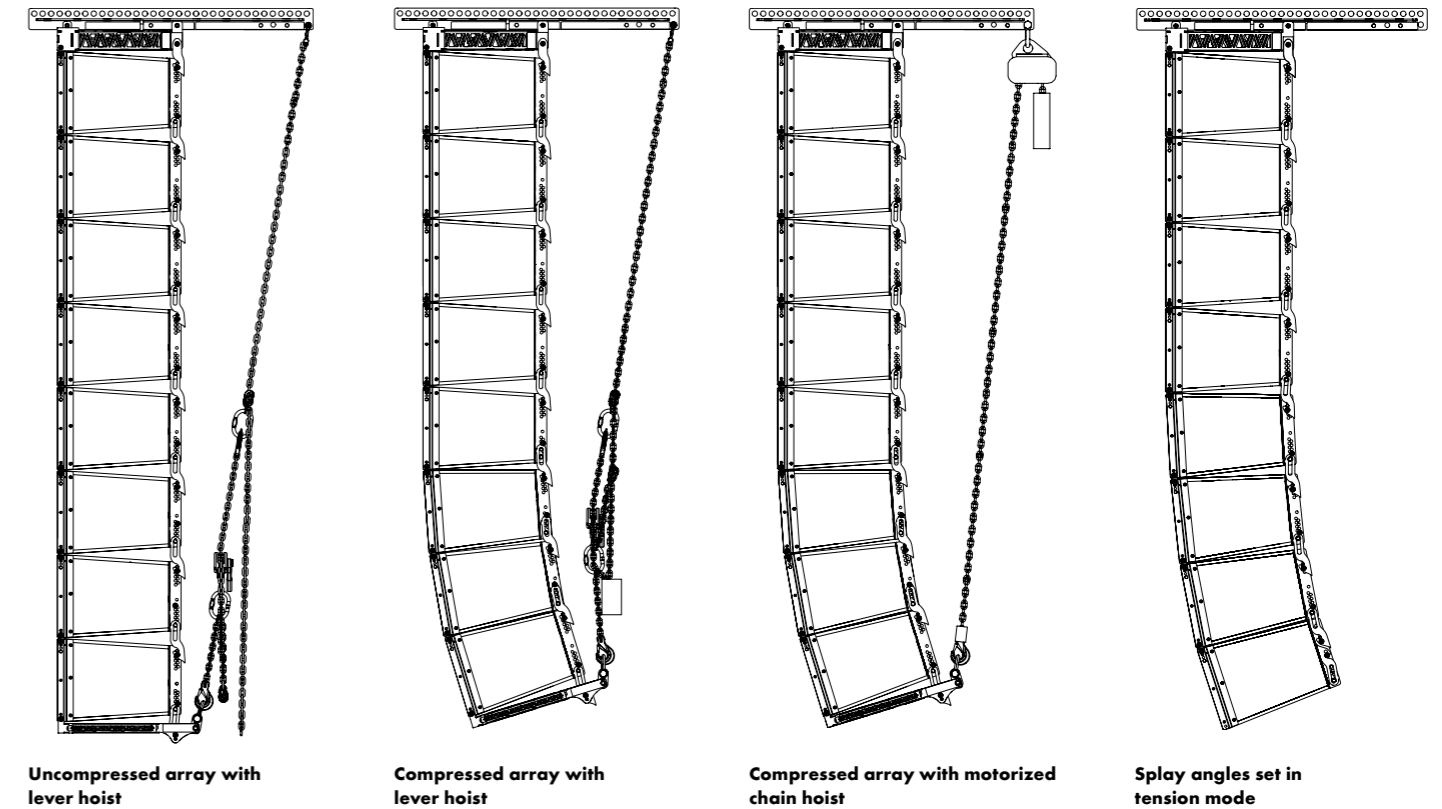

<sup>1</sup> The maximum permitted compression force is 1000 kg (1.0 t/10 kN). The motor hoist must be equipped with two independent brakes (according to the German D8 Plus standard)

# The GSL rigging system

## Safety approval

d&b loudspeakers and accessories are designed for setup and use within situations requiring compliance with the provisions and directives of the DGUV regulation 17 (formerly BGV C1).

### Z5721 GSL Flying frame set

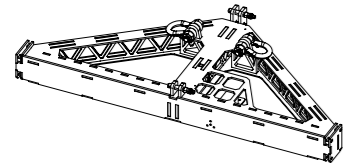

**Z5701**  
GSL Flying frame

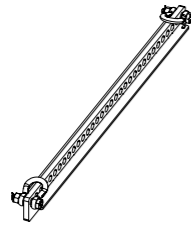

**Z5702**  
GSL Load beam



**Z5705**  
Safety chain 4t



**Z5761**  
ArraySight sender unit

### Z5704 GSL Compression set

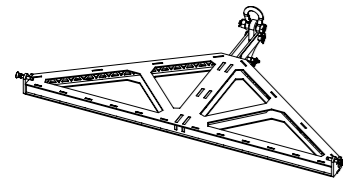

**Z5703**  
GSL Compression frame



**B2447.072**  
Lever hoist



**B2447.074**  
Compression frame master link



**B2447.073**  
Compression grab link



**Z5709**  
Compression chain 2.5t

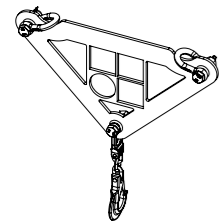

**Z5707**  
SL Aiming plate



**Z5706**  
Hoist connector chain 4t

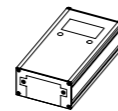

**Z5762**  
ArraySight meter unit

# The GSL rigging examples

These rigging examples are for illustration only. For further information please refer to the TI 385 d&b Line array design as well as the SL-Series Rigging manual, both of which are available for download at [www.dbaudio.com](http://www.dbaudio.com).

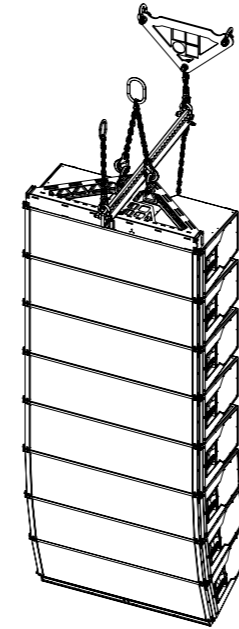

**GSL8/12 Line array 8-deep**  
Compression mode - Front

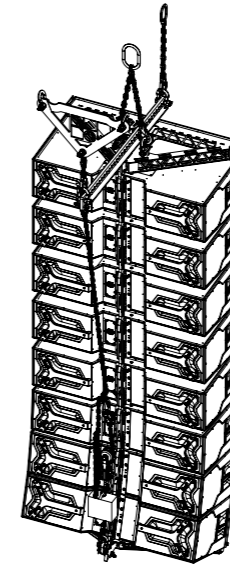

**GSL8/12 Line array 8-deep**  
Compression mode - Rear

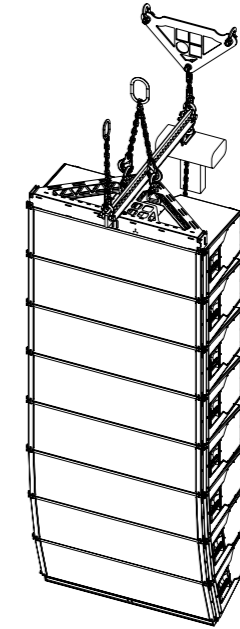

**GSL8/12 Line array 8-deep**  
Compression mode with motor - Front

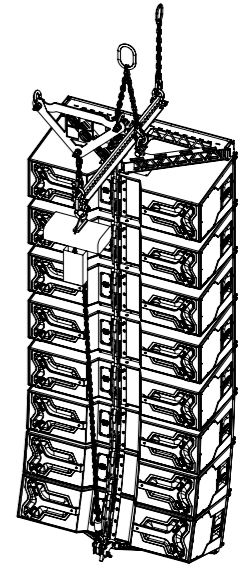

**GSL8/12 Line array 8-deep**  
Compression mode with motor - Rear

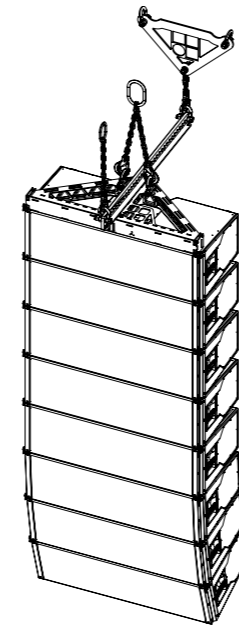

**GSL8/12 Line array 8-deep**  
Tension mode - Front

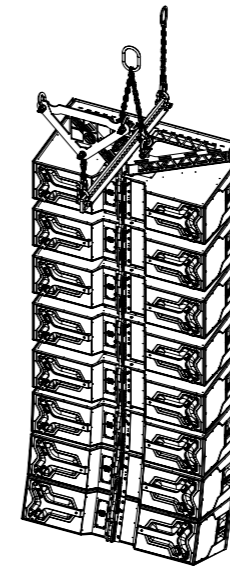

**GSL8/12 Line array 8-deep**  
Tension mode - Rear

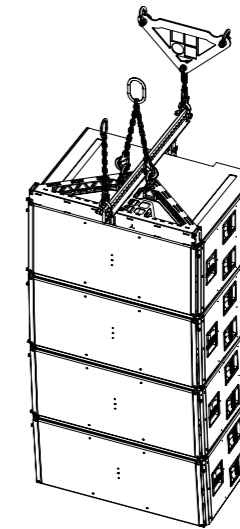

**SL-SUB column 4-deep**  
2° splay - Front

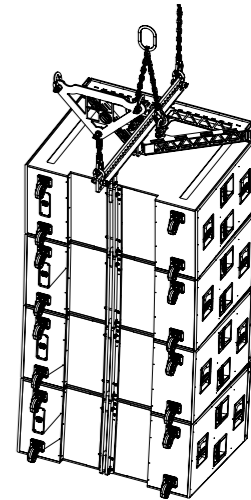

**SL-SUB column 4-deep**  
2° splay - Rear



# The GSL carts

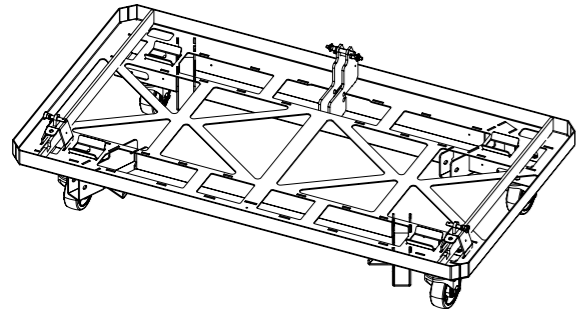

**E7490**  
Touring cart 4 x KSL8/SL12

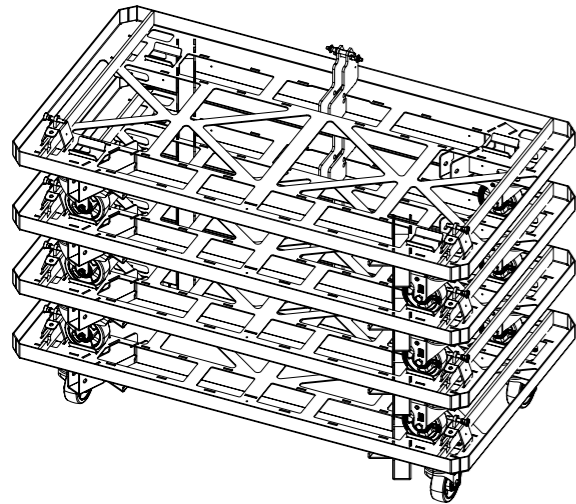

**E7490**  
GSL8/GSL12 Touring cart stackable

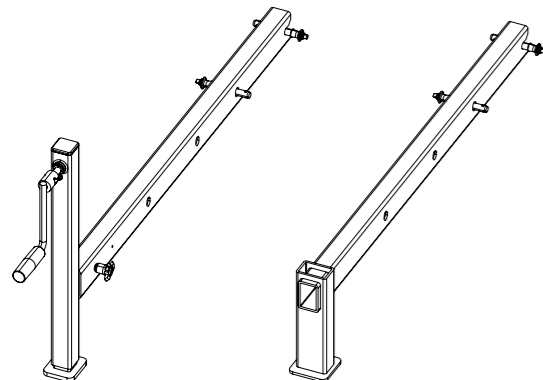

**E7494**  
SL Outriggers

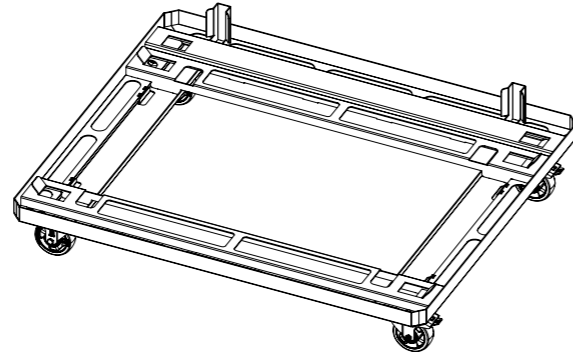

**E7492**  
Touring cart SL-SUB/SL-GSUB

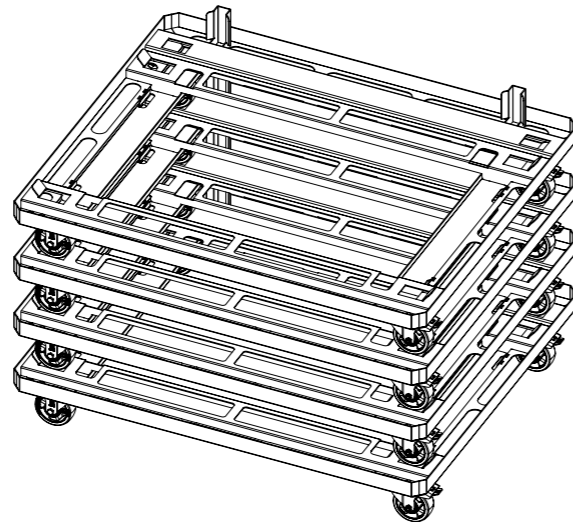

**E7492**  
SL-SUB/SL-GSUB Touring cart stackable

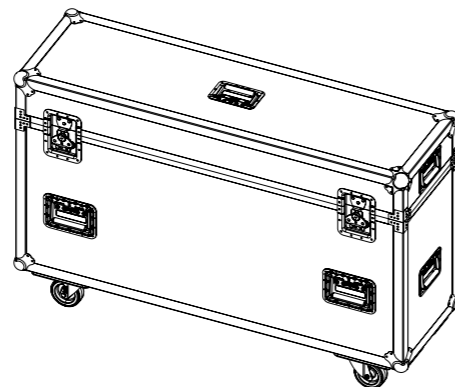

**E7497**  
Touring case GSL compression

# The GSL carts examples

## Safety approval

d&b loudspeakers and accessories are designed for setup and use within situations requiring compliance with the provisions and directives of the DGUV regulation 17 (formerly BGV C1).

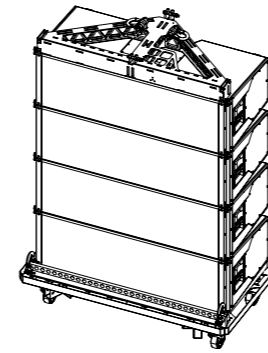

**E7490**  
4 x GSL8/GSL12 Touring cart Loaded in Compression mode with mounted GSL Flying frame

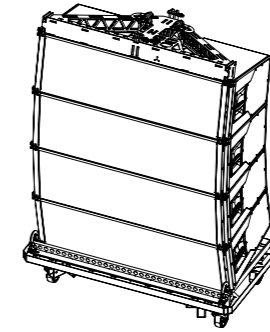

**E7490**  
4 x GSL8/GSL12 Touring cart Loaded in Tension mode with mounted GSL Flying frame

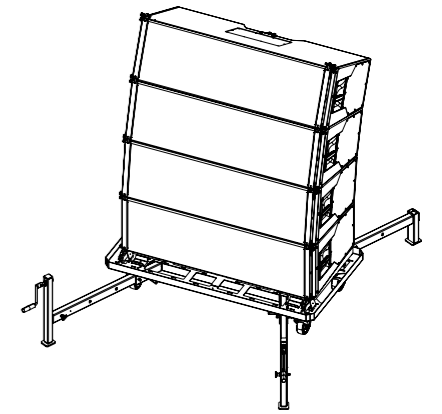

**GSL8/GSL12 Ground stack with E7490 Touring cart and E7494 Outriggers as Ground support**

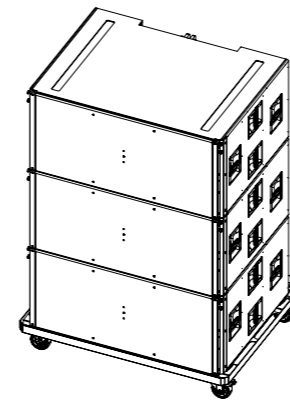

**E7492**  
SL-SUB/SL-GSUB Touring cart

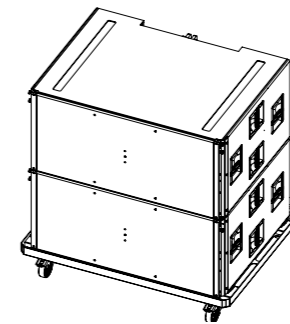

# The d&b ArrayCalc simulation software

The d&b ArrayCalc simulation software is the prediction tool for d&b line arrays, column and point source loudspeakers as well as subwoofers. This is a comprehensive toolbox for all tasks associated with acoustic design, performance prediction, alignment, rigging and safety parameters. For safety reasons d&b line arrays must be designed using the d&b ArrayCalc simulation software. ArrayCalc is available as a native stand-alone application for both Microsoft Windows<sup>1</sup> (Win7 or higher) and Mac OS X<sup>2</sup> (10.7 or higher) operating systems. In combination with the d&b Remote Network, this can significantly reduce setup and tuning time in mobile applications and allows for precise simulations when planning installations. Listening planes can be defined in the venue tab, creating a three dimensional representation of any audience area in a given venue. This can also include balconies, side stalls, arenas, in the round scenarios or festivals. Special functions assist in obtaining accurate dimensions with laser distance finders and inclinometers.

## Simulation

Up to forty flown arrays or subwoofer columns can be defined in a project file as single hangs or in pairs. A selection of d&b point source loudspeakers can also be fully integrated as well as a ground stacked SUB array consisting of up to eighty positions. All can be freely positioned according to their intended application, for example as main hang, outfill, nearfill or delay. Position, orientation, aiming and coverage details are displayed. Level over distance is calculated for each source with high resolution in real time, for either band limited or broadband input signals. The comprehensive simulation precisely models the actual performance of the system, taking into account input level, all system configuration options (such as CUT, CPL, HFC or INFRA), limiter headroom and air absorption. Acoustic obstacles, such as video screens, can be added to a model. Acoustic shadowing, whether by these obstacles, or a balcony overhang, is taken into consideration. The load status of all array rigging components is calculated accurately and displayed to determine whether a given array is within the load tolerance. Subwoofer array design is assisted by coverage and polar plot prediction. A specialized algorithm allows the user to specify subwoofer positions and a coverage angle, which is then converted into appropriate delay settings that result in the desired dispersion. The alignment tab enables different sources to be time aligned to one another, as well as showing arrival times and Sound Pressure Levels at a definable reference point on one of the audience areas. For alignment of the flown system with the ground stacked SUB array, the phase response of both the SUB array and a flown source is calculated at a definable reference point.

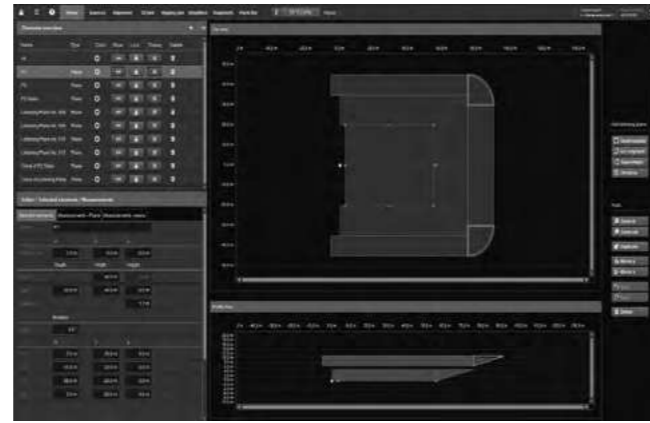

Venue

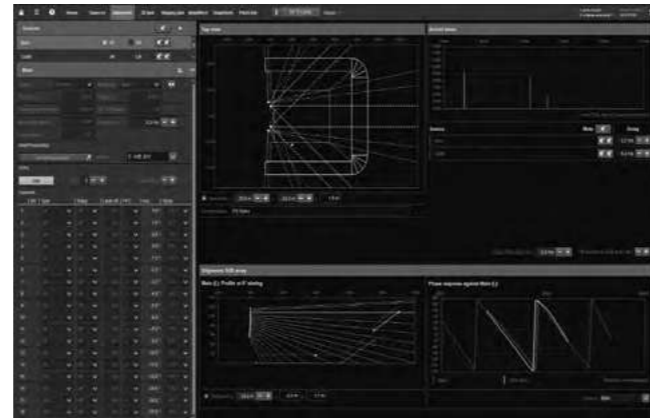

Alignment

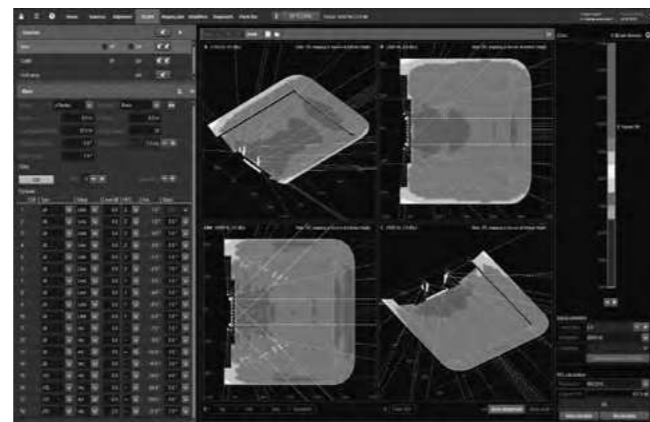

3D Plot quad

Both simulations reflect changes in delay time to the single sources in real time. The d&b ArrayCalc simulation software is available at [www.dbaudio.com](http://www.dbaudio.com), along with further information and video tutorials.

## Prediction

The level distribution resulting from the interaction of all active sources can be mapped onto the audience areas in a three-dimensional view, which can also be zoomed, rotated and exported as a graphics file. EASE and DXF data export capabilities are also available. A rigging plot with all necessary coordinates, dimensions and weights of arrays is generated for export and printing and a parts list, detailing all components required. The d&b ArrayCalc Viewer app presents this key information for positioning and flying a d&b audiotechnik loudspeaker system on a mobile device. Once the system has been designed, calculated and optimized, all relevant project information can be shared via email, AirDrop, or downloaded onto any iOS or Android device.

## ArrayProcessing

The optional ArrayProcessing function applies powerful filter algorithms to optimize the tonal (spectral) and level (spatial) performance of a line array column over the audience area defined by its mechanical vertical coverage angle. Within the d&b ArrayCalc simulation software, spectral and level performance targets over the listening areas can be defined while specific level drops or offsets can be applied to certain areas, to assign reduced level zones. ArrayProcessing applies a combination of FIR and IIR filters to each individual cabinet in an array to achieve the targeted performance, with an additional latency of only 5.9 ms. This significantly improves the linearity of the response over distance as well as seamlessly correcting for air absorption. In addition, ArrayProcessing employs the same frequency response targets for all d&b line arrays, to ensure all systems share a common tonality. This provides consistent sonic results regardless of array length or splay settings. The resulting coverage is enhanced with spectral consistency and defined level distribution, achieving more linear dispersion and total system directivity to cover longer distances or steep listening areas effectively.

## R1 Remote Control Software

R1 uses the same project file created by ArrayCalc and generates an intuitive graphical user interface including complete details of the simulated system, loudspeakers, amplifiers, remote IDs, groups, ArrayProcessing data and all configuration information. This workflow removes the need to manually transfer data from one software program to the other.

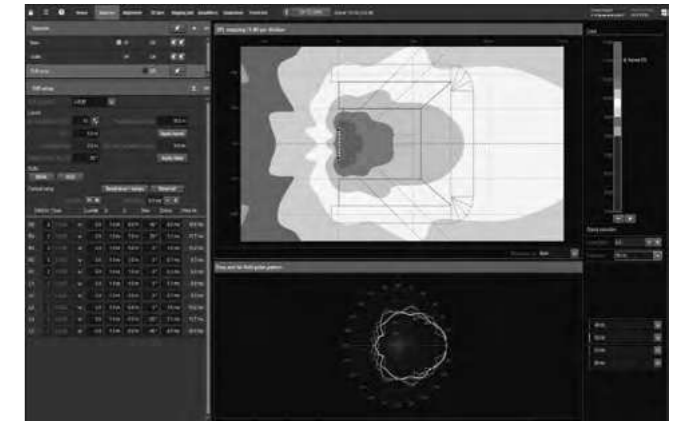

Sources, SUB array

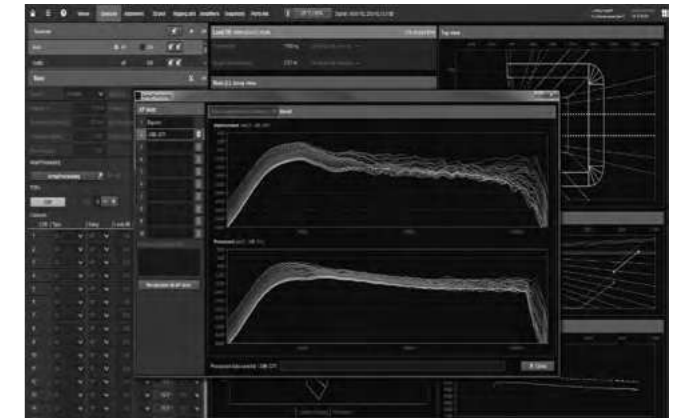

ArrayProcessing

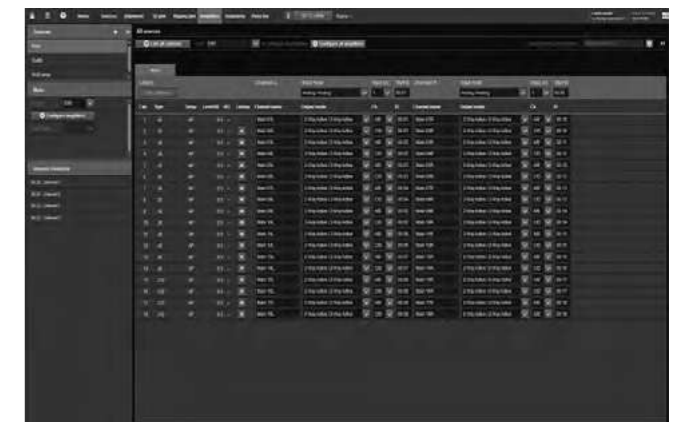

Amplifiers

<sup>1</sup> Microsoft Windows is a registered trademark or trademark of Microsoft Corporation in the United States and/or other countries

<sup>2</sup> Mac OS X is a trademark of Apple Inc., registered in the U.S. and other countries

# The d&b R1 Remote control software

The remote control capability of the d&b Remote Network enables central control and monitoring of a complete d&b loudspeaker system from anywhere in the network, be it from a computer in the control room, at the mix position, or on a wireless tablet in the auditorium. This central access to all functions throughout the d&b Remote Network unlocks the full potential of the d&b system approach. In a typical user workflow, the d&b Remote Network takes settings optimized in the d&b ArrayCalc simulation software and applies these to all the amplifiers within the network.

All functions and controls available on the front panel of d&b amplifiers may be remotely controlled and/or monitored using the d&b R1 Remote control software. This allows each channel of the amplifier to be controlled and enables the creation of groups of loudspeakers. When grouped together, a button or fader can control the overall system level, zone level, equalization and delay, power ON/OFF, MUTE, as well as loudspeaker specific function switches such as CUT/HFA/HFC and CPL. An offline mode is provided for preparation in advance of an event, without the amplifiers being present or connected. d&b System check verifies that the system performs within a predefined condition, while the Array verification function automatically identifies the physical position of a loudspeaker in an array to check that the system is cabled correctly. Extensive facilities for storing and recalling system settings are provided allowing these to be repeated, as and when required. For mobile applications, project files can be easily adjusted for use with a different set of equipment at another location.

The R1 software is optimized for use with touch screen, mouse and keyboard and runs on both Microsoft Windows<sup>1</sup> (Win7 or higher) and Mac OS X<sup>2</sup> (10.7 or higher).

Further information is provided in the d&b Amplifier and Software brochure which is available for download at [www.dbaudio.com](http://www.dbaudio.com).



R1 home screen



R1 in configuration mode

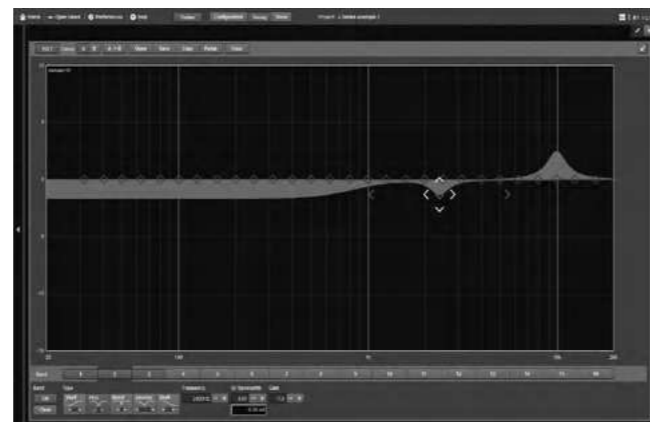

D20/D80 16-band equalizer in R1

# The d&b NoizCalc immission modelling software

The d&b software uses international standards to model the far field noise immission from multiple complex and coherently emitting sources such as line arrays and subwoofer arrays. More and more, gaining permission and licenses to stage live open air events requires an official statement with a prediction of how noise could impact on the surrounding area. NoizCalc takes all complex loudspeaker data and a reference point from the d&b ArrayCalc simulation software and calculates the sound propagation and relative attenuation values towards the far field for a certain scenario with particular meteorological conditions for one or more d&b loudspeaker systems.

A 3D terrain map imported from Google Maps or Street View displays the calculated immission on the areas surrounding the audience listening zones. This visual representation shows the actual system performance in the far field, enabling users to optimize for listeners while satisfying local noise restrictions and offsite regulations.

To ensure reliable results, NoizCalc includes all complex data concerning the addition and subtraction of sound waves, including phase information to describe the combination and interaction effects within a loudspeaker system consisting of multiple line arrays, subwoofer arrays and delay systems.

NoizCalc models immissions in the far field according to the internationally accepted ISO 9613-2 or Nord2000 calculation standards. Ground characteristics can be set depending on the absorbency or reflectivity of surfaces, while areas with volume attenuating properties can be defined. Buildings can be included, and the maximum reflection order option adjusts how many reflections are calculated. Parameters for humidity, air pressure and temperature ensure that the correct air absorption figures are accounted. The ISO 9613-2 standard requires limited meteorological information and assumes a worst-case scenario. The more sophisticated propagation model, Nord2000 enables a more precise handling of meteorological conditions allowing the user to model with prevailing wind information. The d&b NoizCalc immission modelling software is available at [www.dbaudio.com](http://www.dbaudio.com) for registered download, along with further information and video tutorials. It was developed in collaboration with SoundPLAN, a specialist software developer for environmental noise prediction.



Editor

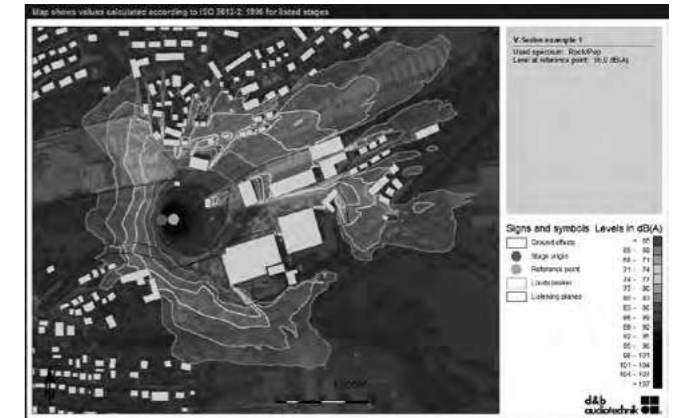

Graphic plot

<sup>1</sup> Microsoft Windows is a registered trademark or trademark of Microsoft Corporation in the United States and/or other countries

<sup>2</sup> Mac OS X is a trademark of Apple Inc., registered in the U.S. and other countries

# The DS10 and DS20 Audio network bridges

## The DS100 Signal Engine

### DS10 Audio network bridge

The DS10 Audio network bridge interfaces between Dante networks and AES3 digital audio signals, while also providing distribution of Ethernet control data. Positioned within the signal chain in front of the amplifiers, this 1 RU device expands the d&b system approach. Each unit can deliver up to sixteen Dante network channels via AES3 digital signal outputs. Additionally, four AES3 input channels provide access to the Dante audio network for applications such as a break-in from a Front of House console. The DS10 incorporates an integrated 5-port switch, offering a primary and redundant network for the Dante protocol, as well as advanced functions such as Multicast Filtering and VLAN modes. Using the DS10 Audio network bridge, audio signals and remote control data can be combined using a single Ethernet cable.



The DS10 Audio network bridge front view



The DS10 Audio network bridge rear view

### DS20 Audio network bridge

The DS20 Audio network bridge supports the open standards-based Milan protocol rather than Dante. Milan (Media integrated local area networking) is a high level interoperability solution based on Audio Video Bridging (AVB) technology. The main advantages are deterministic behaviour (zero network congestion); improved reliability; optimum synchronization and hassle free network setup, as no special settings, such as QoS, need to be set within the switches to ensure delivery.



The DS20 Audio network bridge front view



The DS20 Audio network bridge rear view

### DS100 Signal Engine

The DS100 Signal Engine is the platform underneath the Soundscape, based on a specialized rack mount 3 RU audio processor with Audinate Dante networking. It provides a 64 x 64 audio matrix with level and delay adjustments at all cross points. Additional software modules provide dynamic source positioning and emulated acoustics functions. The DS100 is a versatile tool for use within complex audio systems to route and distribute multiple audio channels to numerous amplifiers driving loudspeaker positions and zones, show relay and break out rooms. The networking capabilities with a Dante enabled processor are significant, particularly for busy, multi-room complexes. The DS100 completely integrates with the overall d&b system approach, including loudspeakers, amplifiers, rigging, transport and networking accessories and the DS10 Audio network bridge. The complete system is designed and optimized in the d&b ArrayCalc simulation software, and controlled via the d&b R1 Remote control software.



The DS100 Signal Engine front view



The DS100 Signal Engine rear view

# The D80 amplifier

The 2 RU four channel D80 amplifier is a high power density amplifier, ideally suited for use mobile environments. The signal delay capability enables user definable settings of up to 10 s (= 3440 m/11286 ft) to be applied independently to each channel. The same applies to the two 16-band equalizers, providing optional parametric, asymmetric, shelving or notch filtering. The D80 incorporates a colour TFT touchscreen, offering quick access to the menu structure, while the rotary encoder can be used for fine adjustment. The front panel and the integrated

touchscreen of the D80 amplifier is tilted up for ease of operation when the amplifier is below eye level. The LoadMatch function integrated within the D80 amplifier electrically compensates the properties of loudspeaker cable used. The D80 incorporates Class D amplifiers utilizing a switched mode power supply with active Power Factor Correction(PFC) suitable for mains voltages 100 V/127 V, 50 - 60 Hz and 208 V/240 V, 50 - 60 Hz and maintains a stable output when used with weak or unstable mains supplies.

D80	
<b>User interface</b>	Encoder/colour TFT touchscreen
<b>Output channels</b>	4
<b>Input channels</b>	4 x AES3 or 4 x analog or 2 x AES3 and 2 x analog
<b>Latency</b>	0.3 msec
<b>User equalizers (per channel)</b>	2 x 16-band
<b>Delay</b>	10 sec/3440 m
<b>Maximum output power (THD+N &lt; 0.5%, 12 dB crest factor)</b>	4 x 2000 W into 8 ohms 4 x 4000 W into 4 ohms
<b>Output routing</b>	Dual Channel, Mix TOP/SUB 2-Way Active
<b>Output connectors</b>	NL4/EP5 plus central NL8
<b>Cable compensation</b>	LoadMatch
<b>Power supply</b>	Autosensing switched mode power supply with active PFC
<b>Mains voltage</b>	100 - 127/208 - 240 V, 50 - 60 Hz
<b>Weight (kg/lb)</b>	19/42
<b>Dimensions</b>	2 RU x 19" x 530 mm
<b>Remote</b>	OCA/AES70 via Ethernet/CAN

### Airflow

## The D80 Touring rack assembly

The d&b 6 x D80 Touring rack assembly and the d&b 3x D80 Touring rack assembly are intended for large scale sound reinforcement applications. They are designed as a complete prewired system amplification rack providing mains power distribution, connector interfaces and all internal cabling for D80 amplifiers. The 19" internal shockmount steel frame also accommodates an I/O panel providing both analog and digital audio signals as well as four network connectors for either Ethernet or CAN-Bus remote networking and a d&b DS10 or DS20 Audio network bridge. The d&b Audio network bridges interface between audio transport networks and AES3 digital audio signals while also providing distribution of Ethernet control data. The DS10 supports Dante networks, while the DS20 is used for the open standards-based Milan protocol.

The Audio network bridges each incorporate an integrated 5-port switch, offering a primary and redundant network. The DS20 5-port switch is fully AVB enabled, while the DS10 offers special functions such as Multicast Filtering and VLAN modes.

The d&b 6 x D80 Touring rack assembly comes with a 2 RU loudspeaker connector panel providing six NL8 (4 channel) and two LKA25 (12 channel) loudspeaker outputs. The loudspeaker connector panel is also equipped with a Power over Ethernet (POE) socket to connect and power a d&b ArraySight inclinometer. The d&b ArraySight inclinometer system is intended to vertically aim an entire array in its operation position. It provides precision angle measurement over a wide measuring angle of  $\pm 90$  degrees. It utilizes an ultra bright green laser to provide a visible indication for aiming the array. The d&b ArraySight sender unit also sends temperature and humidity information to the R1 Remote control software via OCA/AES70. The d&b 3 x D80 Touring rack assembly provides three NL8 (4 channel) and one LKA25 (12 channel) loudspeaker output. Both touring Racks are available with a 32 A CEE mains power distribution or 30 A NEMA mains power distribution panel.



3 x D80 Touring rack front view



6 x D80 Touring rack front view

## The SL-Series system package

The full functionality of any d&b system is instantly inherited from a software suite for planning, modelling and control. This includes ArrayCalc, ArrayProcessing, NoizCalc, and the R1 Remote control software. The DS10 and DS20 Audio network bridges provide connectivity to Dante and Milan networks respectively. Positioned within the signal chain in front of the amplifiers, these 1 RU devices expand the d&b system approach in both mobile and installation environments.

At the heart are the 3 x D80 and 6 x D80 Touring racks which house three and six amplifiers, respectively and utilize the MC24/LKA25 loudspeaker multicore solution.

The 3 x D80 provides a single multicore that will power an array of six KSL loudspeakers, while the 6 x D80 offers two multicore cables that will power an array of twelve KSL loudspeakers with ArrayProcessing.

The d&b SL-Series is a special loudspeaker system, a complete package guaranteeing consistency in transport, cabling, amplification, rigging and operation, with all the performance and reliability advantages of the d&b System reality.



GSL and KSL System package

# The controller setups and operation with D80 amplifier

## Arc and Line setup

The Arc mode is used for line array loudspeakers when used in curved array sections with splay angles between 2° and 7°. The Line mode is used for long throw array sections with three or more consecutive splay settings between 0° and 1°. Compared to the Arc mode, the upper mid range is reduced to compensate for the extended near field.

## AP setup

In connection with ArrayProcessing (AP), the AP setup contains the AP data that are generated in the ArrayCalc simulation software. These are transferred to the applicable amplifiers via the d&b Remote network (OCA/AES70) using R1.

## CUT mode

Set to CUT, the cabinet low frequency level is reduced and it is now configured for use with the d&b SL subwoofer.

## HFC mode

Selecting the HFC (High Frequency Compensation) mode compensates for loss of high frequency energy due to absorption in air when loudspeakers are used to cover far field listening positions. HFC has two settings which should be used selectively, HFC1 for cabinets covering distances larger than 40 m (130 ft) and HFC2 for those covering distances larger than 80 m (260 ft). This can be used to achieve the correct sound balance between close and remote audience areas allowing all amplifiers driving the array to be fed from the same signal source. Thus the whole array performs with comparable headroom.

## CPL function

The CPL (Coupling) function compensates for coupling effects between closely coupled cabinets by reducing the low and mid frequency level. CPL begins gradually at 2 kHz, with the maximum attenuation below 100 Hz, providing a balanced frequency response when SL-Series cabinets are used in arrays of five or more. The CPL function can be set in dB attenuation values between -9 and 0.

## INFRA mode

With the INFRA mode selected, the upper operating frequency of the system is reduced from 30 Hz to 70 Hz. The SL-SUB/SL-GSUB can now be used to supplement applicable d&b loudspeaker systems operated in full range mode.

## Maximum loudspeakers per amplifier

	GSL8	GSL12	SL-SUB	SL-GSUB
<b>D80</b>	2	2	2	2

## Available controller settings

	GSL8	GSL12	SL-SUB	SL-GSUB
<b>Arc/Line</b>	x	x		
<b>AP</b>	x	x	x	
<b>CUT</b>	x	x		
<b>HFC</b>	x	x		
<b>CPL</b>	x	x		
<b>INFRA</b>			x	x

# The GSL System frequency responses

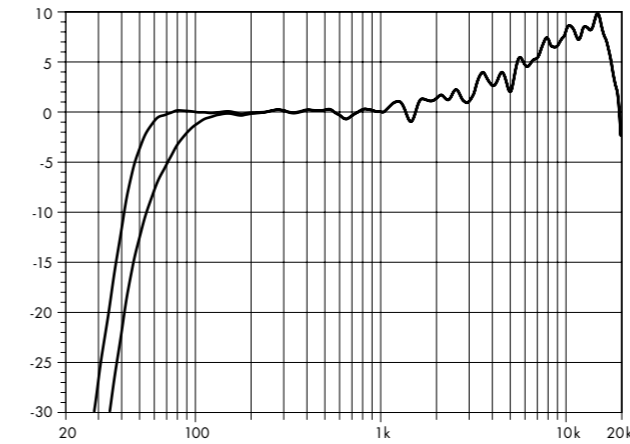

**GSL8 frequency response, standard and CUT modes\***  
\* single cabinet within array

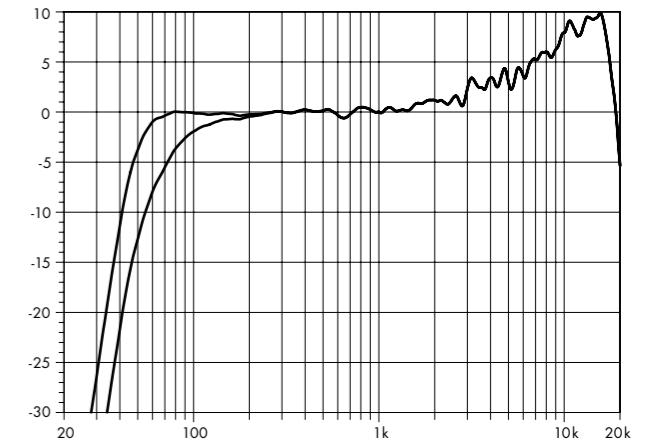

**GSL12 frequency response, standard and CUT modes\***  
\* single cabinet within array

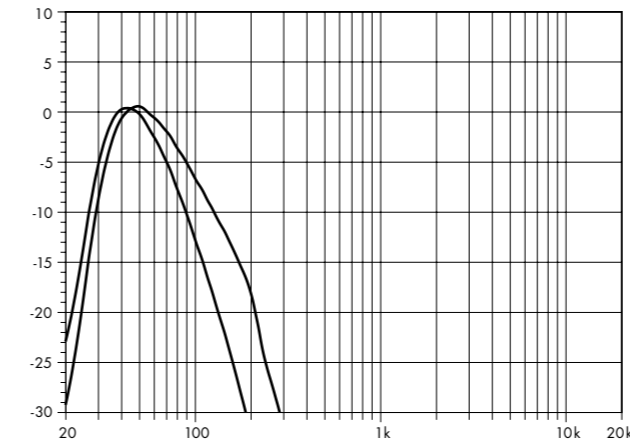

**SL-SUB/SL-GSUB frequency response, standard and INFRA modes**

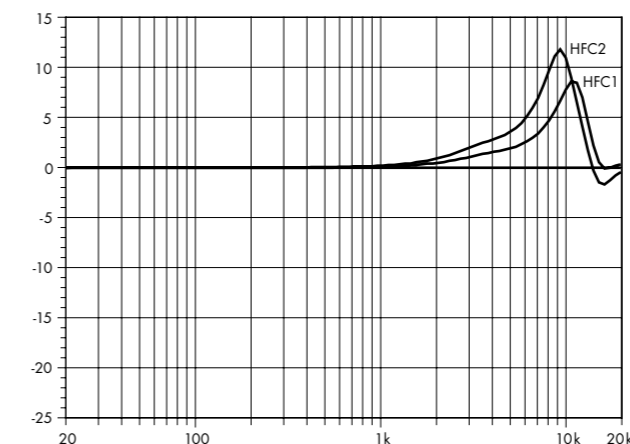

**Correction of HFC\***  
\*schematic diagram

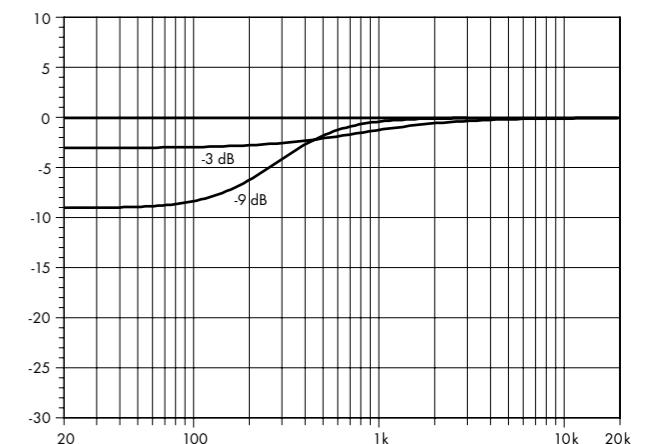

**Correction of CPL\***  
\*schematic diagram

# The GSL System configuration examples

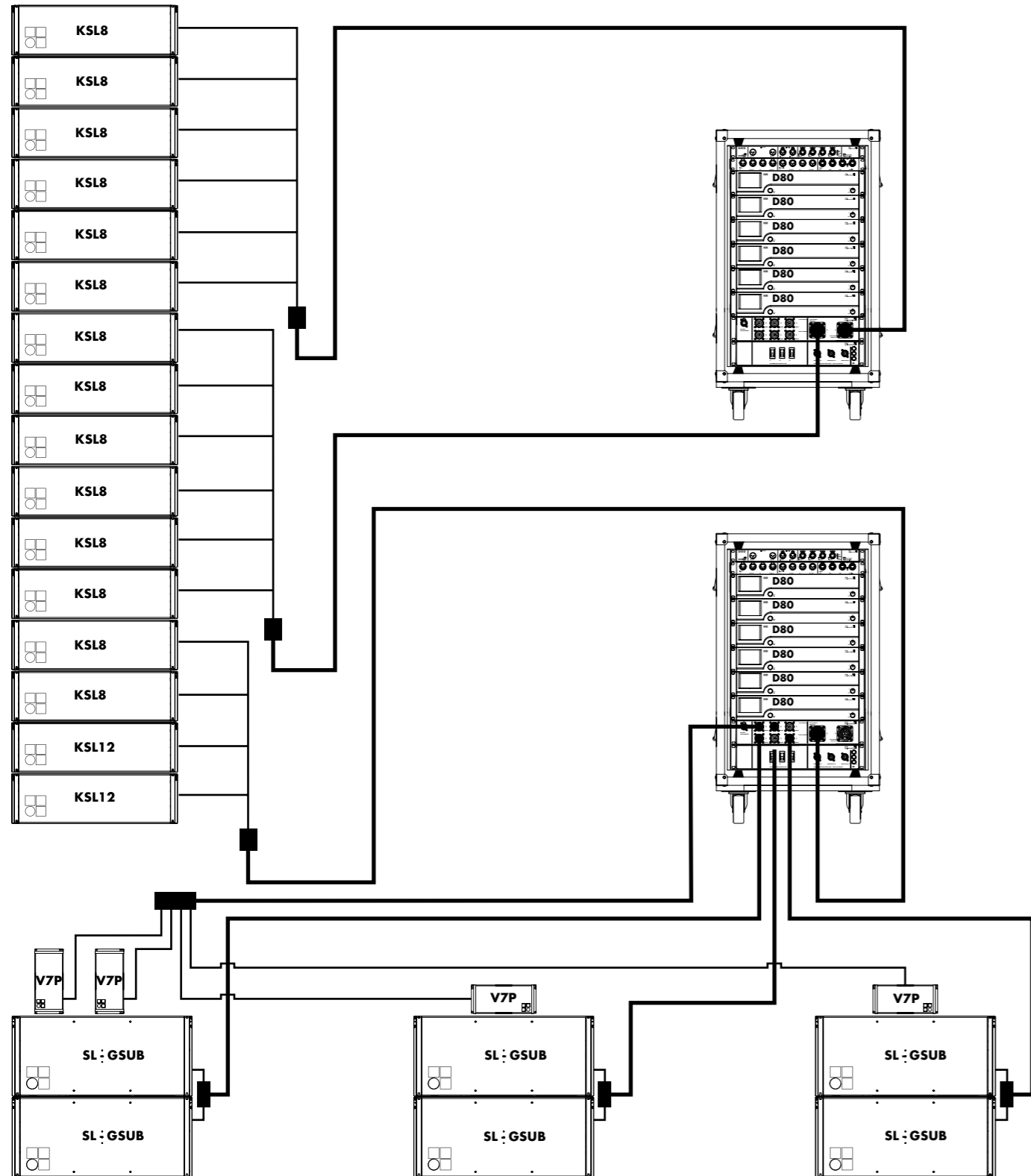

SL-Series arena configuration comprising GSL8/GSL12 mains and V7P frontfills along with ground stacked SL-GSUB with 6 x D80 Touring racks

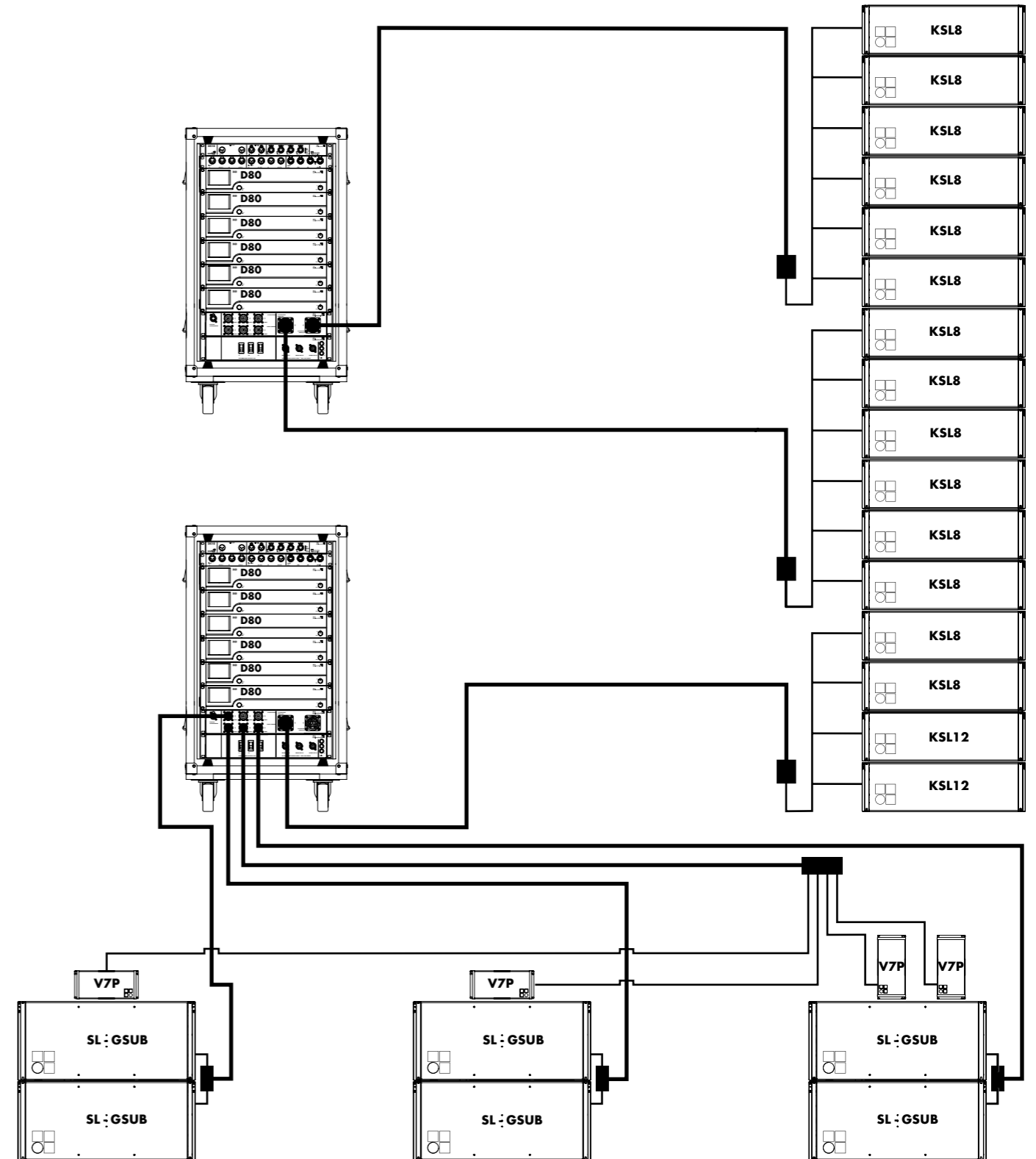

# The GSL System configuration examples

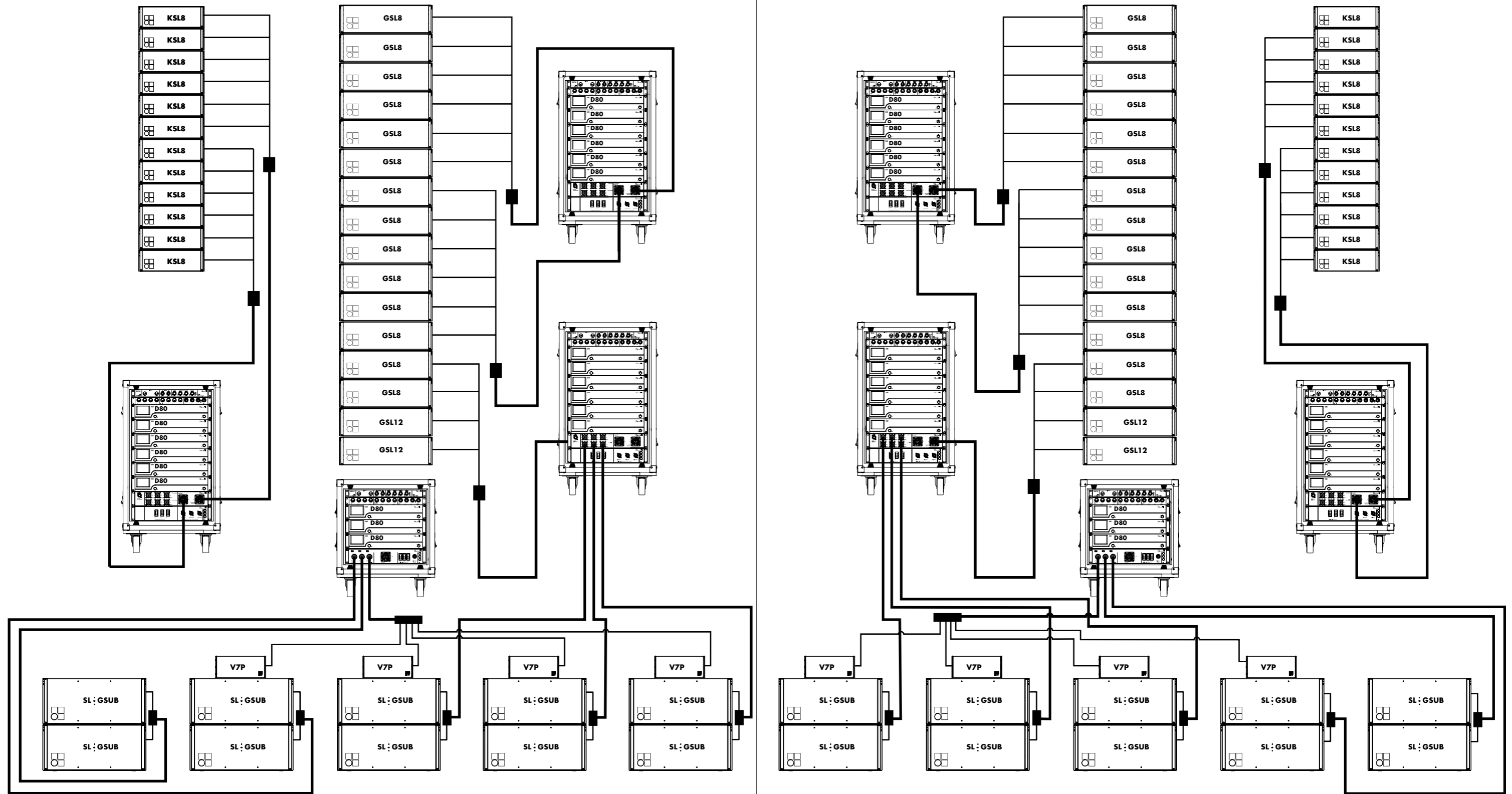

SL-Series festival configuration comprising GSL8/GSL12 mains, KSL8 outfills and V7P frontfills along with ground stacked SL-GSUB with 6 x D80 and 3 x D80 Touring racks



# The GSL System cables and adapters MC8/MC24

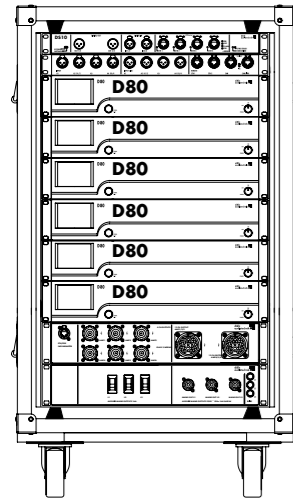

**Z5576**  
6x D80 Touring rack  
OUT: 2x LKA 25/6 x NL8

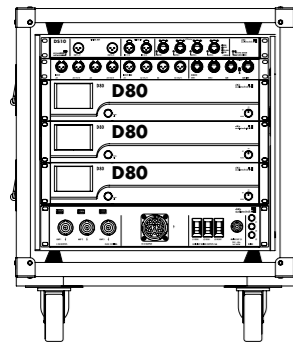

**Z5570/Z5571**  
3x D80 Touring rack  
OUT: 1x LKA 25/3 x NL8

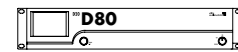

**Z2710 D80 amplifier**  
OUT: 1 x NL8

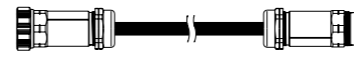
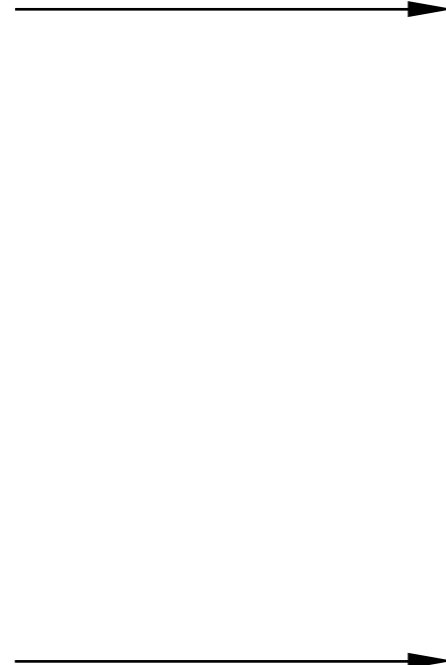

**Z5328.xxxx**  
MC24 LKA25 F/M Multicore



**Z5343.xxxx**  
MC8 Cable NLT8 F/M



**Z5343.xxxx**  
MC8 Cable NLT8 F/M



**Z5325.000**  
LKA25M to 6x NLT4M adapter



**Z5348.002**  
Adapter NLT8F  
to 2 x NLT4M



**Z5347.001**  
Breakoutbox NLT8F  
to 6 x NLT4M



**Z5348.002**  
Adapter NLT8F  
to 2 x NLT4M



**Z5347.001**  
Breakoutbox NLT8F  
to 6 x NLT4M



**Z5340.xxxx**  
MC4 Cable NLT4 F/M



**Z5340.xxxx**  
MC4 Cable NLT4 F/M

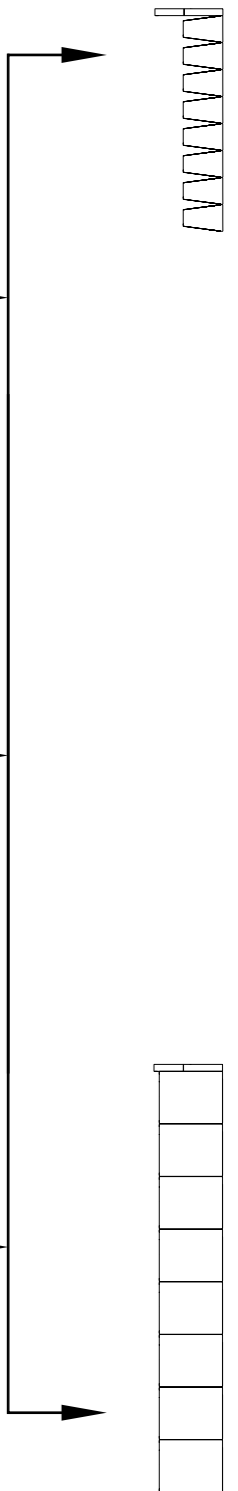

# The GSL System product overview

<b>GSL loudspeakers</b>	Z0750.000	<b>GSL8 Loudspeaker NLT4F</b>
	Z0751.000	<b>GSL12 Loudspeaker NLT4F</b>
	Z0760.000	<b>SL-SUB Subwoofer NLT4F</b>
	Z0761.000	<b>SL-GSUB Subwoofer NLT4F</b>
<b>GSL accessories</b>	Z5708.000	<b>GSL Flying frame set</b>
	Z5704.000	<b>GSL Compression set</b>
	Z5707.000	<b>SL Aiming plate</b>
	Z5706.000	<b>Hoist connector chain 4t</b>
	Z5703.000	<b>GSL Compression frame</b>
	Z5762.000	<b>d&amp;b ArraySight meter unit</b>
	E7499.000	<b>SL-SUB/SL-GSUB Wooden lid</b>
	E7494.000	<b>SL Outriggers</b>
<b>Cart packages</b>	Z7490.750	<b>GSL8 Cart package<sup>1</sup></b>
	Z7490.751	<b>GSL12 Cart package<sup>1</sup></b>
	Z7492.760	<b>3 x SL-SUB Cart Package<sup>2</sup></b>
	Z7492.761	<b>3 x SL-GSUB Cart Package<sup>2</sup></b>
	Z7493.760	<b>2 x SL-SUB Cart package<sup>3</sup></b>
	Z7493.761	<b>2 x SL-GSUB Cart package<sup>3</sup></b>
<b>Carts and cases</b>	E7490.000	<b>Touring cart 4 x GSL8/12</b>
	E7491.000	<b>Touring cart cover GSL8/12</b>
	E7492.000	<b>Touring cart SL-SUB</b>
	E7493.000	<b>Touring cart cover 3 x SL-SUB</b>
	E7498.000	<b>Touring cart cover 2 x SL-SUB</b>
	E7497.000	<b>Touring case GSL compression</b>

<sup>1</sup> Includes 4 x GSL8/12 loudspeakers, GSL Touring cart and GSL Touring cart cover

<sup>2</sup> Includes 3 x SL-SUB/SL-GSUB subwoofers, SL-SUB Touring cart and SL-SUB Touring cart cover

<sup>3</sup> Includes 2 x SL-SUB/SL-GSUB subwoofers, SL-SUB Touring cart and SL-SUB Touring cart cover

<b>Amplifiers</b>	Z2710.xxx	<b>D80 amplifier<sup>4</sup></b>
<b>Processing and distribution</b>	Z4010.000	<b>DS10 Audio network bridge</b>
	Z4011.000	<b>DS20 Audio network bridge</b>
	Z4100.000	<b>DS100 Signal Engine</b>
<b>Amplifier rack assemblies</b>	Z5570.xxx	<b>3 x D80 Touring rack<sup>5</sup></b>
	Z5571.xxx	<b>3 x D80 Touring rack (includes DS10)<sup>5</sup></b>
	Z5576.xxx	<b>6 x D80 Touring rack (includes DS10)<sup>5</sup></b>
<b>Racks</b>	E7468.000	<b>D80 Touring rack 2 RU, 19" SD, shock mounted, handles</b>
	E7483.000	<b>DS100 Touring rack 3 RU, 19" SD, shock mounted, handles</b>
<b>Cables and adapters</b>	Z5343.xxx	<b>MC8 Cable NLT8 F/M</b>
	Z5340.xxx	<b>MC4 Cable NLT4 F/M</b>
	Z5328.xxx	<b>MC24 LKA 25 F/M Multicore</b>
	Z5325.000	<b>Adapter LKA25M to 6 x NLT4M</b>
	Z5348.002	<b>Adapter NLT8F to 2 x NLT4M</b>
	Z5347.001	<b>Breakoutbox NLT8F to 6 x NLT4M</b>

<sup>4</sup> The complete list of mobile amplifier versions is available in the d&b D Amplifier and Software brochure

<sup>5</sup> Further information is available in the d&b D Amplifier and Software brochure

